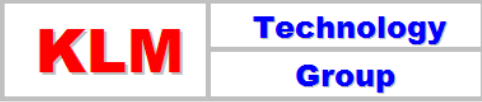

KLM Technology Group Practical Engineering Guidelines for Processing Plant Solutions	 SOLUTIONS, STANDARDS, SOFTWARE www.klmtechgroup.com	Page : 1 of 95
		Rev: 02 Rev 01 April 2014 Rev 02 May 2014
KLM Technology Group #03-12 Block Aronia, Jalan Sri Perkasa 2 Taman Tampoi Utama 81200 Johor Bahru Malaysia	REFRIGERATION SYSTEMS (PROCESS ENGINEERING EQUIPMENT DESIGN GUIDELINE)	Co- Author: Rev 01 Mochamad Adha Firdaus Rev 02 Aprilia Jaya Editor: Karl Kolmetz

KLM Technology Group has developed; 1) Process Engineering Equipment Design Guidelines, 2) Equipment Design Software, 3) Project Engineering Standards and Specifications, and 4) Unit Operations Manuals. Each has many hours of engineering development.

KLM is providing the introduction to this guideline for free on the internet. Please go to our website to order the complete document.

www.klmtechgroup.com

TABLE OF CONTENT

INTRODUCTION	4
Scope	4
General Design Consideration	6
DEFINITION	20
NOMENCLATURE	23

KLM Technology Group Practical Engineering Guidelines for Processing Plant Solutions	REFRIGERATION SYSTEMS (PROCESS ENGINEERING EQUIPMENT DESIGN GUIDELINES)	Page 2 of 95
		Rev: 02
		April 2014

THEORY OF THE DESIGN	24
Carnot Refrigeration Cycle	24
Refrigerant Nomenclature	27
Selecting Refrigerant	32
Mechanical Refrigeration	33
Equipments for Mechanical Refrigeration	50
Absorption Refrigeration	76
APPLICATION	83
Application 1: Vapor-Compression Refrigeration System (Single Stage)	83
Application 2: Vapor-Compression Refrigeration System (Multi Stage)	86
Application 3: Cascade System	89
Interpolation	92
REFERENCE	93
LIST OF TABLE	
Table 1: Types of Refrigeration Systems	9
Table 2: Refrigeration Properties	27
Table 3: Typical Water inlet Temperature	67
Table 4: Fouling Resistance, R	67
Table 5: Refrigeration System Checklist	81

These design guideline are believed to be as accurate as possible, but are very general and not for specific design cases. They were designed for engineers to do preliminary designs and process specification sheets. The final design must always be guaranteed for the service selected by the manufacturing vendor, but these guidelines will greatly reduce the amount of up front engineering hours that are required to develop the final design. The guidelines are a training tool for young engineers or a resource for engineers with experience.

This document is entrusted to the recipient personally, but the copyright remains with us. It must not be copied, reproduced or in any way communicated or made accessible to third parties without our written consent.

KLM Technology Group Practical Engineering Guidelines for Processing Plant Solutions	REFRIGERATION SYSTEMS (PROCESS ENGINEERING EQUIPMENT DESIGN GUIDELINES)	Page 3 of 95
		Rev: 02
		April 2014

LIST OF FIGURE

Figure 1: Components of a Refrigeration System	6
Figure 2: Basic Refrigeration Cycle	7
Figure 3: Basic Methods for Refrigeration	10
Figure 4: Vapor – Compression Cycle	11
Figure 5: Basic Absorption Refrigeration System	13
Figure 6: Steam – Jet Refrigeration	14
Figure 7: One-Stage Refrigeration System (GPSA, 2004)	16
Figure 8: Two-Stage Refrigeration System (GPSA, 2004)	17
Figure 9: Three-Stage Refrigeration System (GPSA, 2004)	18
Figure 10: Carnot refrigeration cycle ; (a) schematic diagram and (b) T – S Diagram for Carnot Cycle	25
Figure 11: Refrigerant Safety Group Classifications	30
Figure 12: p-h diagram for vapor compression cycle (ideal)	34
Figure 13: p-h Diagram for vapor compression cycle (actual)	36
Figure 14: Subcooling liquid from condenser	38
Figure 15: Recirculating system	41
Figure 16: Cascade system	42
Figure 17: T-S diagram for cascade system	43
Figure 18: p-h diagram for Cascade System	44
Figure 19: Two-stage system with evaporating temperature, flash-gas, & intercooling	47
Figure 20: T-S diagram for multistage systems	48
Figure 21: Operating curve for compressor	51
Figure 22: Example of V-type reciprocating compressor	54
Figure 23: Oil cooling in a screw compressor	56
Figure 24: Screw compressor, dual rotor	57
Figure 25: Screw compressor, mono rotor	58
Figure 26: Example of centrifugal compressor	64

These design guideline are believed to be as accurate as possible, but are very general and not for specific design cases. They were designed for engineers to do preliminary designs and process specification sheets. The final design must always be guaranteed for the service selected by the manufacturing vendor, but these guidelines will greatly reduce the amount of up front engineering hours that are required to develop the final design. The guidelines are a training tool for young engineers or a resource for engineers with experience.

This document is entrusted to the recipient personally, but the copyright remains with us. It must not be copied, reproduced or in any way communicated or made accessible to third parties without our written consent.

KLM Technology Group Practical Engineering Guidelines for Processing Plant Solutions	REFRIGERATION SYSTEMS (PROCESS ENGINEERING EQUIPMENT DESIGN GUIDELINES)	Page 4 of 95
		Rev: 02
		April 2014

Figure 27: Horizontal shell-and-tube condenser	66
Figure 28: Vertical condenser	68
Figure 29: Evaporative Condenser	70
Figure 30: A Horizontal shell-and-tube Evaporator	73
Figure 31: Ammonia absorption refrigeration cycle	77
Figure 32: Process Flow Diagram of Lithium-Bromide Water System	96

These design guideline are believed to be as accurate as possible, but are very general and not for specific design cases. They were designed for engineers to do preliminary designs and process specification sheets. The final design must always be guaranteed for the service selected by the manufacturing vendor, but these guidelines will greatly reduce the amount of up front engineering hours that are required to develop the final design. The guidelines are a training tool for young engineers or a resource for engineers with experience.

This document is entrusted to the recipient personally, but the copyright remains with us. It must not be copied, reproduced or in any way communicated or made accessible to third parties without our written consent.

KLM Technology Group Practical Engineering Guidelines for Processing Plant Solutions	REFRIGERATION SYSTEMS (PROCESS ENGINEERING EQUIPMENT DESIGN GUIDELINES)	Page 5 of 95
		Rev: 02
		April 2014

KLM Technology Group is providing the introduction to this guideline for free on the internet. Please go to our website to order the complete document.

www.klmtechgroup.com

INTRODUCTION

Scope

Refrigeration is a very important unit operation. During the 1990's, it was estimated that annual investment in refrigeration machinery and equipment exceeded \$100 billion and the value of the products treated by refrigeration exceeded \$1 trillion.

Types of refrigeration may be categorized within five broad areas of application that touch most of our daily lives:

1. Daily devices, like household refrigerator / freezers.
2. Commercial equipment systems in example of supermarket display, restaurants, and cafeterias.
3. Food processing like refrigerated warehouse.
4. Industrial tools, in example of liquefaction of gases, chemical process cooling, and crystallization.
5. Public Transportation (refrigerated truck or trailer and marine containers).

This Refrigeration design guideline covers the basic elements in the field of Refrigeration Systems in detail to allow an engineer to design a Refrigeration System with the suitable size of refrigeration needed, work input, coefficient of performance (COP), electric power input and selecting refrigerant which is to be utilized. This design guideline includes design of single stage, multi stage and cascade refrigeration systems.

A refrigeration system is a combination of components and equipment connected in a sequential order to produce the desired refrigeration effect (cooling or heating). Refrigeration maintains the temperature of the heat source below that of its surroundings while transferring the extracted heat, and any required energy input, to a heat sink, atmospheric air, or surface water.

The design of a Refrigeration System may be influenced by factors, including process requirements, economics and safety. In theory section, there are figures that assist in making these calculations from the varying reference sources.

These design guideline are believed to be as accurate as possible, but are very general and not for specific design cases. They were designed for engineers to do preliminary designs and process specification sheets. The final design must always be guaranteed for the service selected by the manufacturing vendor, but these guidelines will greatly reduce the amount of up front engineering hours that are required to develop the final design. The guidelines are a training tool for young engineers or a resource for engineers with experience.

This document is entrusted to the recipient personally, but the copyright remains with us. It must not be copied, reproduced or in any way communicated or made accessible to third parties without our written consent.

KLM Technology Group Practical Engineering Guidelines for Processing Plant Solutions	REFRIGERATION SYSTEMS (PROCESS ENGINEERING EQUIPMENT DESIGN GUIDELINES)	Page 6 of 95
		Rev: 02
		April 2014

Include in this guideline is a calculation spreadsheet for the engineering design. All the important parameters use in the guideline are explained in the definition section which help the reader more understand the meaning of the parameters or the term used.

In the application section of this guideline, three case studies are shown and discussed in detail, highlighting the way to apply the theory for the calculation. The theory section explained about Carnot cycles, selecting refrigerant, single stage, multistage, cascade stage and other equipment that used in the refrigeration system.

General Design Considerations

Refrigeration is used as a method to cool a process stream to a lower temperature than water or air cooling will allow. Refrigeration can be described as the process of cooling materials where the heat transferred from a lower to a higher temperature by doing work such as mechanical Mans; The temperature may spans the range of -157°C to $+4^{\circ}\text{C}$.

Ultra low temperature cooling from absolute zero, -273°C to -157°C , is commonly referred to as cryogenics. By adding work to a system, a fluid can be continuously cycled in a closed loop and provide cooling indefinitely. Sometimes, the heat transfer is used to provide energy to drive the refrigeration cycle.

Types of refrigeration may be categorized within five abroad areas of application :

6. Daily devices, like household refrigerator / freezers.
7. Commercial equipment systems in example of supermarket display, restaurants, and cafetarias.
8. Food processing like refrigerated warehouse.
9. Industrial tools, in example of liquefcation of gases, chemical process cooling, and crystallization.
10. Public Transportation (refrigerated truck or trailer and marine containers).

These design guideline are believed to be as accurate as possible, but are very general and not for specific design cases. They were designed for engineers to do preliminary designs and process specification sheets. The final design must always be guaranteed for the service selected by the manufacturing vendor, but these guidelines will greatly reduce the amount of up front engineering hours that are required to develop the final design. The guidelines are a training tool for young engineers or a resource for engineers with experience.

This document is entrusted to the recipient personally, but the copyright remains with us. It must not be copied, reproduced or in any way communicated or made accessible to third parties without our written consent.

KLM Technology Group Practical Engineering Guidelines for Processing Plant Solutions	REFRIGERATION SYSTEMS (PROCESS ENGINEERING EQUIPMENT DESIGN GUIDELINES)	Page 7 of 95
		Rev: 02
		April 2014

Generally, refrigeration is used for temperature requirements from 80 – 85°F to as near absolute zero as the process demands. The petrochemical and chemical range does not go much below -200°F. Refrigeration process consists of five component equipments, they are:

1. Compressor.
2. Evaporator.
3. Condenser.
4. Expansion Valve.
5. And Refrigerant.

A general equipment arrangement of Refrigeration cycle shows in Figure 1.

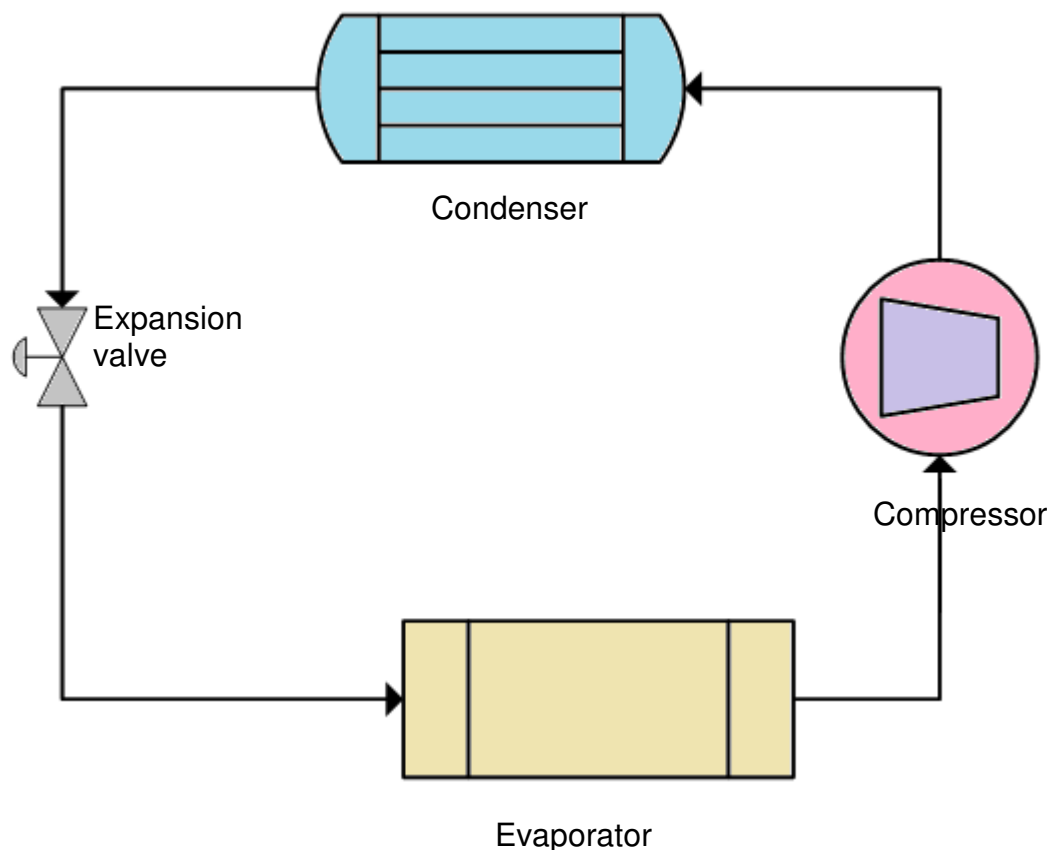

Figure 1. Components of a Refrigeration system.

These design guideline are believed to be as accurate as possible, but are very general and not for specific design cases. They were designed for engineers to do preliminary designs and process specification sheets. The final design must always be guaranteed for the service selected by the manufacturing vendor, but these guidelines will greatly reduce the amount of up front engineering hours that are required to develop the final design. The guidelines are a training tool for young engineers or a resource for engineers with experience.

This document is entrusted to the recipient personally, but the copyright remains with us. It must not be copied, reproduced or in any way communicated or made accessible to third parties without our written consent.

KLM Technology Group Practical Engineering Guidelines for Processing Plant Solutions	REFRIGERATION SYSTEMS (PROCESS ENGINEERING EQUIPMENT DESIGN GUIDELINES)	Page 8 of 95
		Rev: 02
		April 2014

Refrigerant vapor enters the compressor suction and the compressor raises the refrigerant pressure so the saturation temperature is above the temperature of the available cooling medium. This difference allows transfer of heat from the vapor to the cooling medium so that the vapor can condense to a liquid. The condensed liquid then flows through the expansion device such as expansion valve and flashes into a vapor, cooling the remaining liquid refrigerant below the temperature of the product to be cooled.

This difference in temperature allows heat to be transferred from the product to the refrigerant, causing the refrigerant to evaporate. The vapor formed must be removed by the compressor at a rate sufficient to maintain the low pressure in the evaporator and keep the refrigerant flowing. The resulting continuous flow process is referred to as the refrigeration cycle, shown schematically in Figure 2. This cycle is also called the reverse ranking cycle and is governed by the principles of thermodynamics.

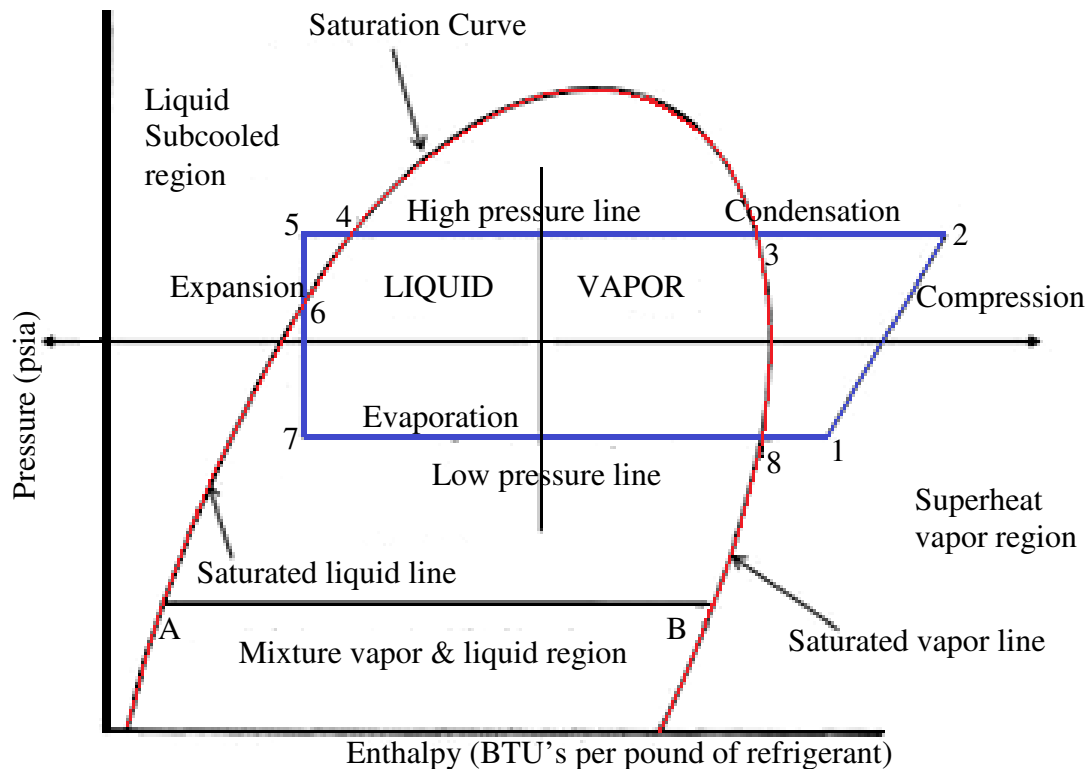

Figure 2. Basic Refrigeration Cycle.

These design guideline are believed to be as accurate as possible, but are very general and not for specific design cases. They were designed for engineers to do preliminary designs and process specification sheets. The final design must always be guaranteed for the service selected by the manufacturing vendor, but these guidelines will greatly reduce the amount of up front engineering hours that are required to develop the final design. The guidelines are a training tool for young engineers or a resource for engineers with experience.

This document is entrusted to the recipient personally, but the copyright remains with us. It must not be copied, reproduced or in any way communicated or made accessible to third parties without our written consent.

KLM Technology Group Practical Engineering Guidelines for Processing Plant Solutions	REFRIGERATION SYSTEMS (PROCESS ENGINEERING EQUIPMENT DESIGN GUIDELINES)	Page 9 of 95
		Rev: 02
		April 2014

The refrigeration capacity is known as the rate of heat removal from the refrigerated space, standard measurement for the terms is refrigeration ton. It represents the amount of the heat that must be removed from a short ton (909 kg) of water to form ice in 24 hours. The amount is 3.51 kWt (12,000 Btu / hours) or equals to 211 kJ/min (200 Btu/min). The cooling load of a typical 200-m² residence is in the 3-ton (10 kW) range. It is conventional to designate a kilowatt of refrigeration as a thermal kilowatt (kWt) to distinguish it from the amount of electricity (kWe) required to produce the refrigeration.

1. Expansion. Liquid refrigerant is flashed across a control valve or other device to a lower temperature and pressure become two phases. The enthalpy of the resulting liquid and vapor must be the same as the enthalpy of the initial liquid or isenthalpic (vertical line on the pressure-enthalpy diagram on figure).
2. Evaporation. The two phase fluid formed in the expansion step is sent to a heat exchanger (typically called a chiller or evaporator) with low pressure and temperature then the cold refrigerant and the warm process gas exchange heat. The process fluid temperature decreases but the refrigerant's temperature stays constant as it evaporates (heat absorbed by the refrigerant equal to its latent heat of vaporization).
3. Compression. The saturated vapor from the previous step is sent to a compressor, which compresses the vapor to a higher temperature and pressure. Frictional losses in the evaporator and piping cause the suction vapor to be slightly superheated.
4. Condensation. The high pressure superheated vapor from the compressor is then cooled and condensed at a relatively constant pressure. The cooling medium in the condenser is usually water, air, and another refrigerant depending on the condensation pressure required. Then it is ready to be sent back to the expansion step to start the cycle over again.

These design guideline are believed to be as accurate as possible, but are very general and not for specific design cases. They were designed for engineers to do preliminary designs and process specification sheets. The final design must always be guaranteed for the service selected by the manufacturing vendor, but these guidelines will greatly reduce the amount of up front engineering hours that are required to develop the final design. The guidelines are a training tool for young engineers or a resource for engineers with experience.

This document is entrusted to the recipient personally, but the copyright remains with us. It must not be copied, reproduced or in any way communicated or made accessible to third parties without our written consent.

KLM Technology Group Practical Engineering Guidelines for Processing Plant Solutions	REFRIGERATION SYSTEMS (PROCESS ENGINEERING EQUIPMENT DESIGN GUIDELINES)	Page 10 of 95
		Rev: 02
		April 2014

There are many ways to obtain the refrigerating effect. Usually, they are grouped in three major allocations :

1. Mechanical Refrigeration.
2. Steam Jet Refrigeration.
3. Absorption Refrigeration.

Table 1. Types of Refrigeration Systems

System	Approx. Temp. Coolant Range, °F	Refrigerant
Stream jet	35 to 70°F	Water
Absorption		
Water-Lithium Bromide	40 to 70°F	Lithium Bromide Solution (*Water)
Ammonia	- 40 to +30°F	Ammonia*-Water
Mechanical compression		
Reciprocating		
Centrifugal or rotary	-200° to +40°F	Ammonia halogenated hydrocarbons, propane, ethylene and others
Screw		
Cryogenics	-150° to – 200°F	Liquefaction of gases

*Refrigerant

All of the methods are using similar process to produce refrigeration effect : Evaporation, Condensation, and Expansion. The difference between them is in the way compression is done to the refrigerant. Figure 3 shows the basic method for refrigeration and the difference between them.

These design guideline are believed to be as accurate as possible, but are very general and not for specific design cases. They were designed for engineers to do preliminary designs and process specification sheets. The final design must always be guaranteed for the service selected by the manufacturing vendor, but these guidelines will greatly reduce the amount of up front engineering hours that are required to develop the final design. The guidelines are a training tool for young engineers or a resource for engineers with experience.

This document is entrusted to the recipient personally, but the copyright remains with us. It must not be copied, reproduced or in any way communicated or made accessible to third parties without our written consent.

KLM Technology Group Practical Engineering Guidelines for Processing Plant Solutions	REFRIGERATION SYSTEMS (PROCESS ENGINEERING EQUIPMENT DESIGN GUIDELINES)	Page 11 of 95
		Rev: 02
		April 2014

The mechanical refrigeration used a Compressor, the Absorption (and desorption) process used the thermal energy forces, while the Steam Jet process used pressure difference from Ejector.

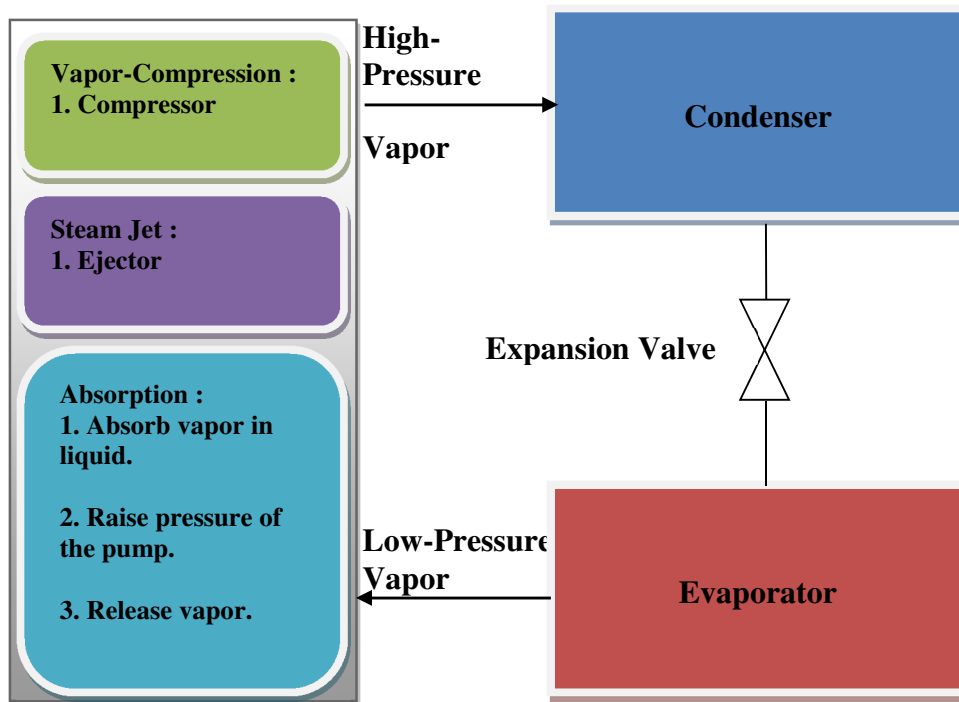

Figure 3. Basic Methods for Refrigeration

These design guideline are believed to be as accurate as possible, but are very general and not for specific design cases. They were designed for engineers to do preliminary designs and process specification sheets. The final design must always be guaranteed for the service selected by the manufacturing vendor, but these guidelines will greatly reduce the amount of up front engineering hours that are required to develop the final design. The guidelines are a training tool for young engineers or a resource for engineers with experience.

This document is entrusted to the recipient personally, but the copyright remains with us. It must not be copied, reproduced or in any way communicated or made accessible to third parties without our written consent.

KLM Technology Group Practical Engineering Guidelines for Processing Plant Solutions	REFRIGERATION SYSTEMS (PROCESS ENGINEERING EQUIPMENT DESIGN GUIDELINES)	Page 12 of 95
		Rev: 02
		April 2014

A. Mechanical Refrigeration

One of the most well-known refrigeration method for the mechanical refrigeration is Vapor-Compressor Systems or sometimes also called Vapor-Compression Cycles. Isothermal processes are realized through isobaric evaporation and condensation in the tubes. Figure 4 marked the standard vapor compression refrigeration cycle.

Work that produced in turbine is small. Therefore, the turbine equipment could be replaced by an expansion valve for efficiency. Nonetheless, wet compression is substituted to an compression vapor for the reasons of proper compressor function.

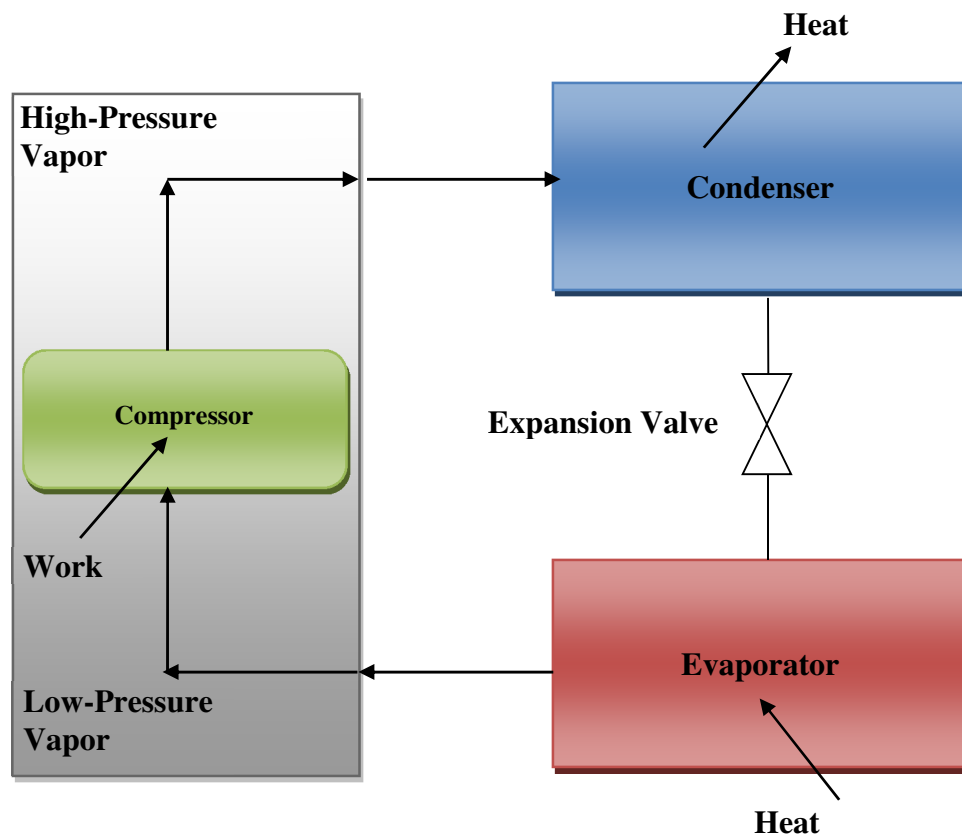

Figure 4. Vapor-Compression Cycle

These design guideline are believed to be as accurate as possible, but are very general and not for specific design cases. They were designed for engineers to do preliminary designs and process specification sheets. The final design must always be guaranteed for the service selected by the manufacturing vendor, but these guidelines will greatly reduce the amount of up front engineering hours that are required to develop the final design. The guidelines are a training tool for young engineers or a resource for engineers with experience.

This document is entrusted to the recipient personally, but the copyright remains with us. It must not be copied, reproduced or in any way communicated or made accessible to third parties without our written consent.

KLM Technology Group Practical Engineering Guidelines for Processing Plant Solutions	REFRIGERATION SYSTEMS (PROCESS ENGINEERING EQUIPMENT DESIGN GUIDELINES)	Page 13 of 95
		Rev: 02
		April 2014

B. Absorption Refrigeration

Absorption refrigeration is a form that is economically attractive when there is a source of thermal energy at a temperature between 100 to 200 °C. An example of inexpensive thermal energy sources are, solar energy, waste heat from cogeneration or process steam plants, geothermal energy, and natural gas when available at a low price.

The absorption refrigeration involve the absorption process of a refrigerant by a transport medium called absorbent to form a liquid solution. The liquid solution the pumped to the higher pressure. Due to the average specific volume of the liquid solution is much less than of the refrigerant vapor , significantly less work is needed. Accordingly, absorption refrigeration system have the advantage of relatively small work input compared to vapor-compression system.

Absorption refrigeration systems differ from compressor refrigerating systems at least in two major aspects :

1. The refrigerant drawn out of the evaporator is compressed not by a mechanical process, but by a thermal heat-exchange which consists of an absorber, a generator, and a pump.
2. Operation of thermal compressors requires a solvent (for a second working fluid) as well as refrigerant.

Two most generous industrial absorption-type refrigeration systems are :

1. Aqua ammonia system.
2. Lithium bromide-water system.

Both of the system respectively used ammonia and water as the refrigerant. Ammonia – water is used for evaporating temperature on the range -60 until 10 °C, while water-lithium bromide is used for evaporating temperatures more than 0 °C. No other any pair components had been suggested that widely used except the two of them. Figure 5 represents the basic absorption refrigeration system.

These design guideline are believed to be as accurate as possible, but are very general and not for specific design cases. They were designed for engineers to do preliminary designs and process specification sheets. The final design must always be guaranteed for the service selected by the manufacturing vendor, but these guidelines will greatly reduce the amount of up front engineering hours that are required to develop the final design. The guidelines are a training tool for young engineers or a resource for engineers with experience.

This document is entrusted to the recipient personally, but the copyright remains with us. It must not be copied, reproduced or in any way communicated or made accessible to third parties without our written consent.

KLM Technology Group Practical Engineering Guidelines for Processing Plant Solutions	REFRIGERATION SYSTEMS (PROCESS ENGINEERING EQUIPMENT DESIGN GUIDELINES)	Page 14 of 95
		Rev: 02
		April 2014

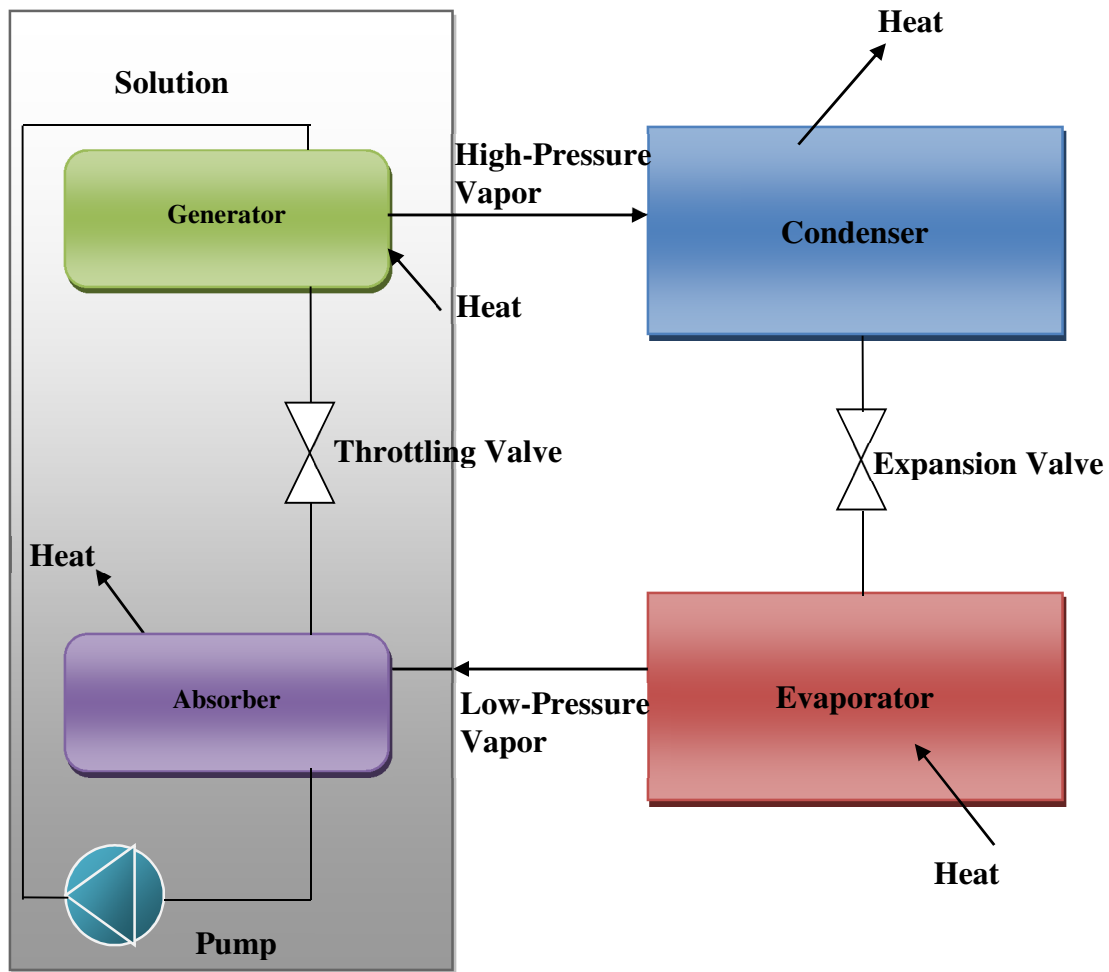

Figure 5. Basic Absorption Refrigeration System.

These design guideline are believed to be as accurate as possible, but are very general and not for specific design cases. They were designed for engineers to do preliminary designs and process specification sheets. The final design must always be guaranteed for the service selected by the manufacturing vendor, but these guidelines will greatly reduce the amount of up front engineering hours that are required to develop the final design. The guidelines are a training tool for young engineers or a resource for engineers with experience.

This document is entrusted to the recipient personally, but the copyright remains with us. It must not be copied, reproduced or in any way communicated or made accessible to third parties without our written consent.

KLM Technology Group Practical Engineering Guidelines for Processing Plant Solutions	REFRIGERATION SYSTEMS (PROCESS ENGINEERING EQUIPMENT DESIGN GUIDELINES)	Page 15 of 95
		Rev: 02
		April 2014

C. Steam-Jet Refrigeration

The steam-jet refrigeration system could be defined as a thermally drive compression system in which vapor is compressed in a jet apparatus. An example of this operation illustrated in Figure 6.

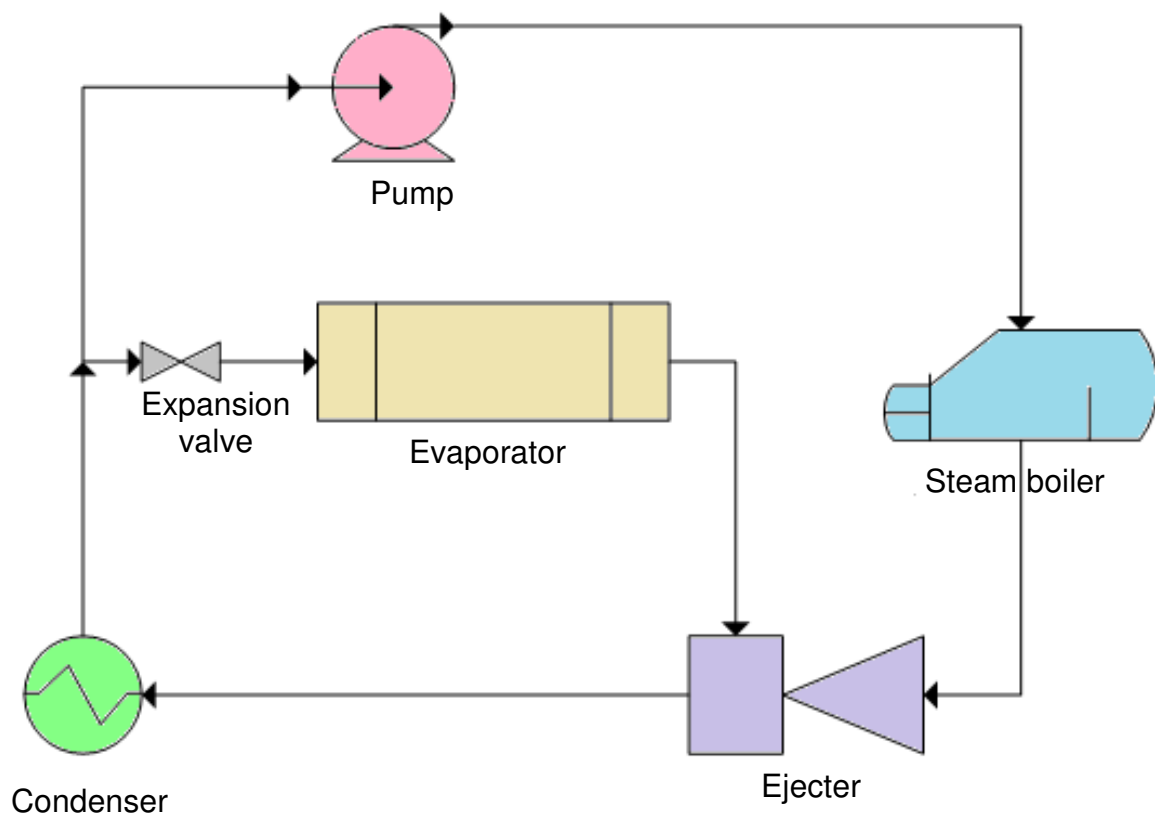

Figure 6. Steam-Jet Refrigeration.

These design guideline are believed to be as accurate as possible, but are very general and not for specific design cases. They were designed for engineers to do preliminary designs and process specification sheets. The final design must always be guaranteed for the service selected by the manufacturing vendor, but these guidelines will greatly reduce the amount of up front engineering hours that are required to develop the final design. The guidelines are a training tool for young engineers or a resource for engineers with experience.

This document is entrusted to the recipient personally, but the copyright remains with us. It must not be copied, reproduced or in any way communicated or made accessible to third parties without our written consent.

KLM Technology Group Practical Engineering Guidelines for Processing Plant Solutions	REFRIGERATION SYSTEMS (PROCESS ENGINEERING EQUIPMENT DESIGN GUIDELINES)	Page 16 of 95
		Rev: 02
		April 2014

Steam is generated at pressure p_1 in boiler and the mass flow rate is m_1 . By using the nozzle, the steam is expanded to the pressure p_0 prevailing in the evaporator, then it would mixed with the steam from the evaporator in the mixing chamber. After that, the pressure of the two streams is raised to the condensation pressure in the device called diffuser. Virtually, all the kinetic energy is transformed into the pressure. When the heat is withdrawn in the condenser, the steam will condenses.

The condensate is separate into two substreams and it's delivered to the steam boiler by a driven force from a pump. Thus, one of the mass flow rate stream is led to the evaporator through an expansion valve. Here, the substream evaporates and absorbing the heat, and then exitung expanded steam, moving at a higher velocity, sucks this stream into the mixing chamber.

Water, mainly employed as a working steam and also as refrigerant in the steam-jet refrigeration system. It is a low-cost, free of hazard, having a high specific enthalpy of evaporation. The pressure p_0 operates usually between 0.6 until 1.2 kPa, while p_c operates between 3 until 8 kPa, depending on the cooling-water temperature.

The steam-jet refrigeration is suited for many applications such as :

1. Direct vaporization for heat-sensitive foods and chemicals drying. Mostly, for preservation of the product quality.
2. Absorption of gases like CO_2 , SO_2 , ClO_2 in chilled water.

Assuming the water greater than 35°F is needed and that water and steam costs are reasonable, there are several advantages of steam jet units that could be achieved following :

1. No moving devices, except the pumps.
2. Low pressure system.
3. Compact design and could be installed on the outdoors.
4. Economical process, since the cooling water and steam could easily be adjusted.
5. Low maintenance and Vibration-free.
6. Simple start up and operation.
7. Cost per ton of refrigeration is relatively low.

These design guideline are believed to be as accurate as possible, but are very general and not for specific design cases. They were designed for engineers to do preliminary designs and process specification sheets. The final design must always be guaranteed for the service selected by the manufacturing vendor, but these guidelines will greatly reduce the amount of up front engineering hours that are required to develop the final design. The guidelines are a training tool for young engineers or a resource for engineers with experience.

This document is entrusted to the recipient personally, but the copyright remains with us. It must not be copied, reproduced or in any way communicated or made accessible to third parties without our written consent.

KLM Technology Group Practical Engineering Guidelines for Processing Plant Solutions	REFRIGERATION SYSTEMS (PROCESS ENGINEERING EQUIPMENT DESIGN GUIDELINES)	Page 17 of 95
		Rev: 02
		April 2014

Refrigeration Stages

Refrigeration systems utilizing one, two, three, or four stages of compression have been successfully operated in various services. The number of levels of refrigeration generally depends upon the number of compression stages required, interstage heat loads, economics, and the type of compression.

i. One-Stage System

A typical one-stage refrigeration system is shown in Fig. 7 where the data are for pure propane refrigerant.

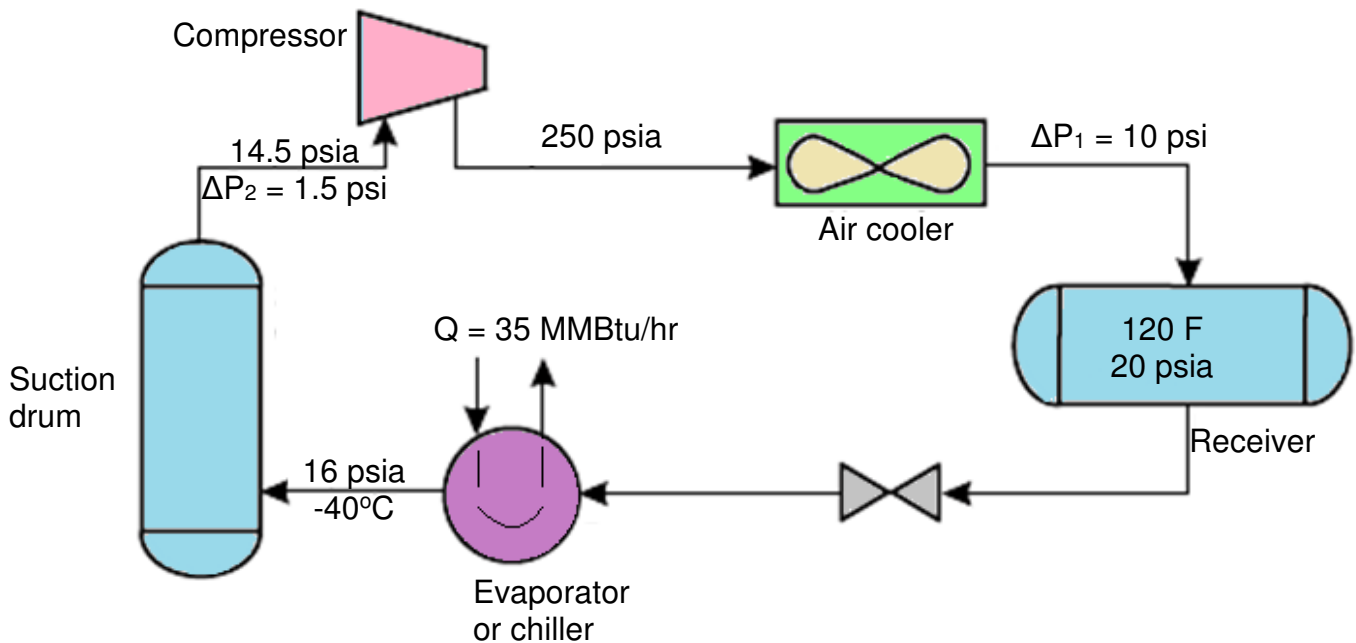

Figure 7: One-Stage Refrigeration System

These design guideline are believed to be as accurate as possible, but are very general and not for specific design cases. They were designed for engineers to do preliminary designs and process specification sheets. The final design must always be guaranteed for the service selected by the manufacturing vendor, but these guidelines will greatly reduce the amount of up front engineering hours that are required to develop the final design. The guidelines are a training tool for young engineers or a resource for engineers with experience.

This document is entrusted to the recipient personally, but the copyright remains with us. It must not be copied, reproduced or in any way communicated or made accessible to third parties without our written consent.

KLM Technology Group Practical Engineering Guidelines for Processing Plant Solutions	REFRIGERATION SYSTEMS (PROCESS ENGINEERING EQUIPMENT DESIGN GUIDELINES)	Page 18 of 95
		Rev: 02
		April 2014

ii. Two-Stage System

A two-stage refrigeration system and interstage flash economizer can savings in the range 20%. Also removing process heat at the interstage level rather than at the low stage level. A typical two-stage system with an intermediate load is shown in Fig. 8 with data for pure propane.

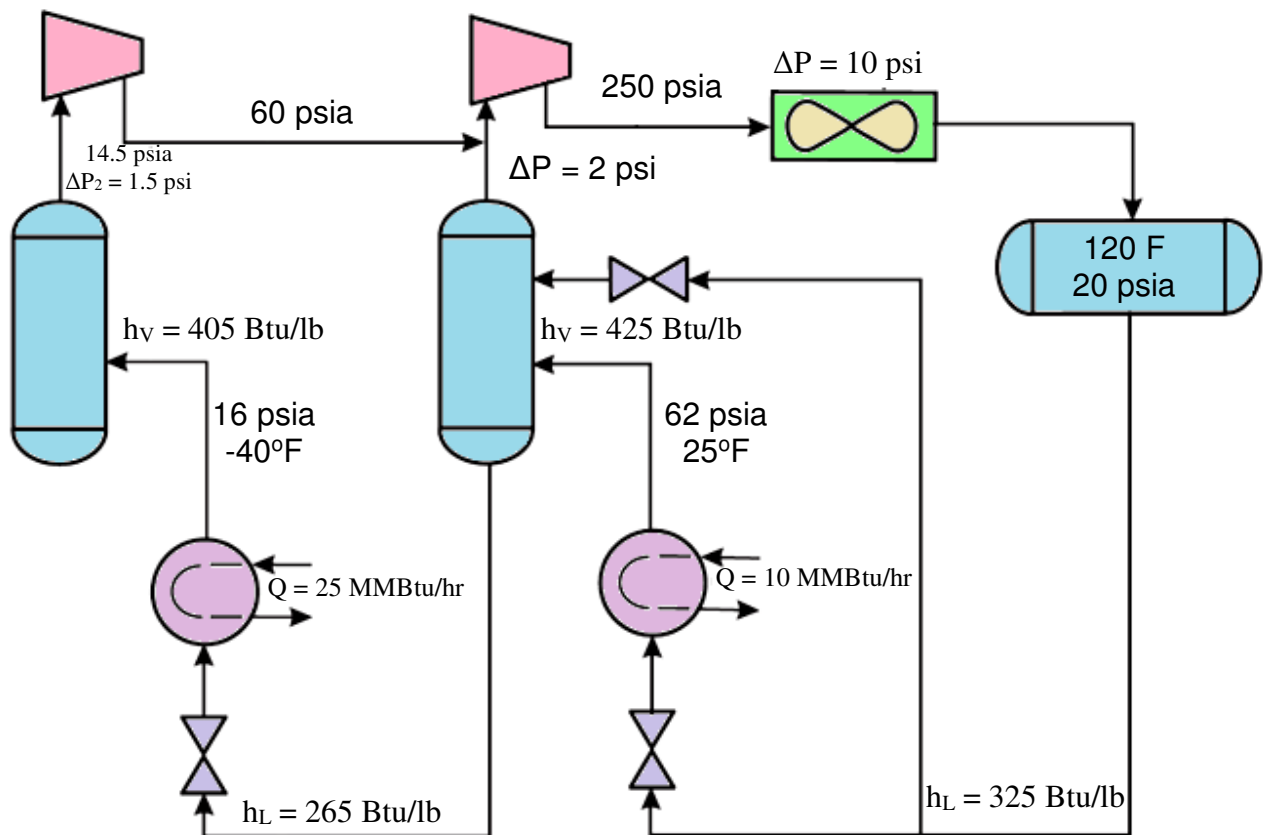

Figure 8: Two-Stage Refrigeration System

These design guideline are believed to be as accurate as possible, but are very general and not for specific design cases. They were designed for engineers to do preliminary designs and process specification sheets. The final design must always be guaranteed for the service selected by the manufacturing vendor, but these guidelines will greatly reduce the amount of up front engineering hours that are required to develop the final design. The guidelines are a training tool for young engineers or a resource for engineers with experience.

This document is entrusted to the recipient personally, but the copyright remains with us. It must not be copied, reproduced or in any way communicated or made accessible to third parties without our written consent.

KLM Technology Group Practical Engineering Guidelines for Processing Plant Solutions	REFRIGERATION SYSTEMS (PROCESS ENGINEERING EQUIPMENT DESIGN GUIDELINES)	Page 19 of 95
		Rev: 02
		April 2014

iii. Three-Stage System

A three-stage compression system can save horsepower. The flash economization and/or an intermediate heat load can be used in this system although not result dramatic savings as the two stage versus one-stage. A typical three stage propane system is shown in Fig. 9.

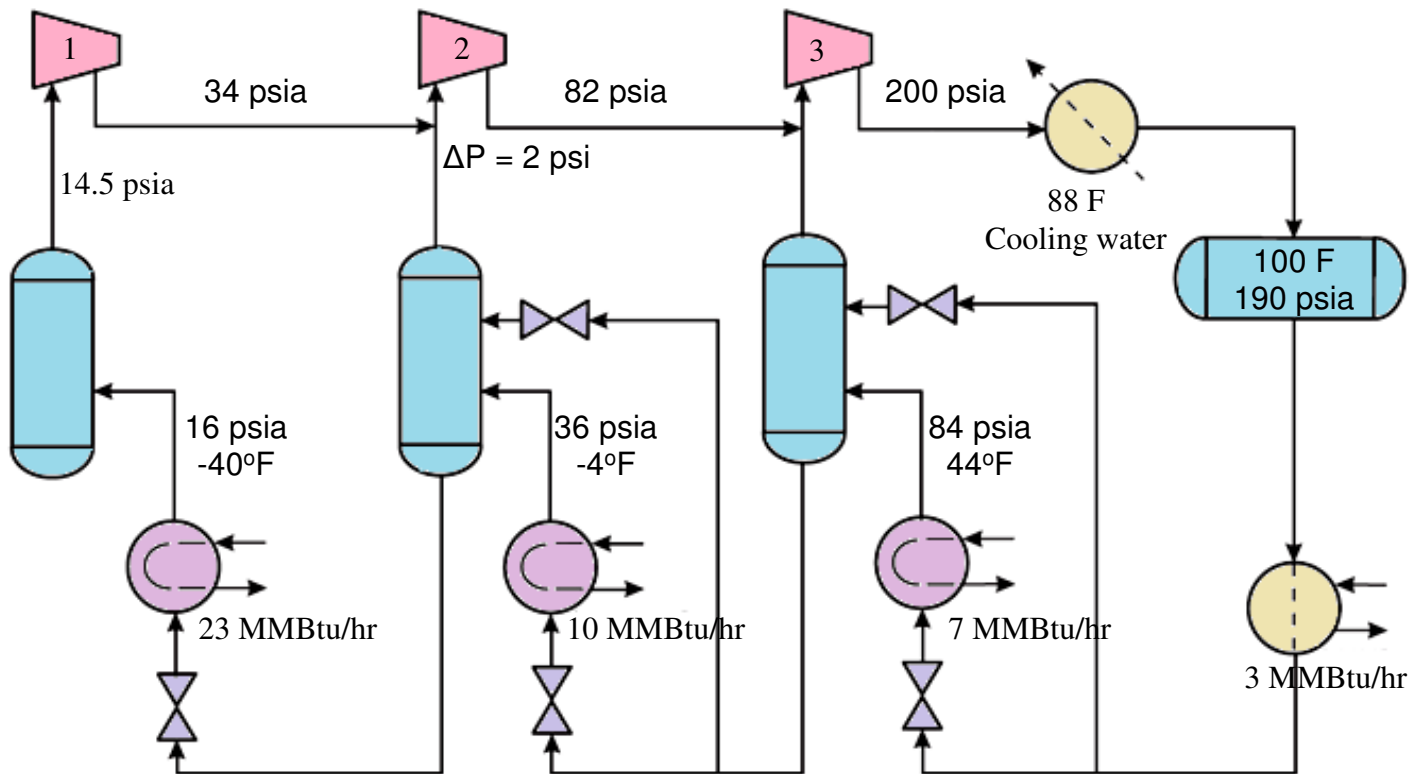

Figure 9: Three-Stage Refrigeration System

These design guideline are believed to be as accurate as possible, but are very general and not for specific design cases. They were designed for engineers to do preliminary designs and process specification sheets. The final design must always be guaranteed for the service selected by the manufacturing vendor, but these guidelines will greatly reduce the amount of up front engineering hours that are required to develop the final design. The guidelines are a training tool for young engineers or a resource for engineers with experience.

This document is entrusted to the recipient personally, but the copyright remains with us. It must not be copied, reproduced or in any way communicated or made accessible to third parties without our written consent.

KLM Technology Group Practical Engineering Guidelines for Processing Plant Solutions	REFRIGERATION SYSTEMS (PROCESS ENGINEERING EQUIPMENT DESIGN GUIDELINES)	Page 20 of 95
		Rev: 02
		April 2014

Equipment required

Below is the equipment required in the refrigeration systems (Younger 2004). Some of the will discuss detailed in the theory.

1. Compressors. Both reciprocating compressors and centrifugal used. Centrifugal are preferred because of lower maintenance generally not used when HP requirements are below 1000.
2. Condensers. The condensers must remove all the heat taken out of the evaporator plus the heat of compression. The condenser can be either water cooled or air cooled.
3. Water cooled. These are standard water cooled, well designed shell and tube exchangers. They make the system have lower temperature condenser than a system with air cooled.
4. Air cooled. These standard air cooled condensers. The lowest condensing temperature that probably can be expected is about 20 F above the design ambient temperature and thus the system requires more HP.
5. Economizer. This is an intermediate flash vessel that gets rid of some of the vapors that would be formed on direct throttling. Two stages are often used when more than two compression stages are used.
6. Throttling valve. This is a standard control valve mostly operated on level control from the evaporator of chiller.
7. Evaporator (or chiller). A standard U-tube heat exchanger in which the refrigerant is normally on the outside of the tubes is used. A good disengaging space should be provided in the top of the refrigerant side to prevent liquid entrainment.
8. Suction scrubber. This is a large vessel complete with the entrainment separators, automatic liquid level dumps to prevent any liquid carryover into the compressor
9. Auxiliaries. Such units as refrigerant driers, oil removal facilities, pures, etc.

These design guideline are believed to be as accurate as possible, but are very general and not for specific design cases. They were designed for engineers to do preliminary designs and process specification sheets. The final design must always be guaranteed for the service selected by the manufacturing vendor, but these guidelines will greatly reduce the amount of up front engineering hours that are required to develop the final design. The guidelines are a training tool for young engineers or a resource for engineers with experience.

This document is entrusted to the recipient personally, but the copyright remains with us. It must not be copied, reproduced or in any way communicated or made accessible to third parties without our written consent.

KLM Technology Group Practical Engineering Guidelines for Processing Plant Solutions	REFRIGERATION SYSTEMS (PROCESS ENGINEERING EQUIPMENT DESIGN GUIDELINES)	Page 21 of 95
		Rev: 02
		April 2014

DEFINITIONS

Absorption-refrigeration – One refrigeration process that uses heat-transfer (thermal) driving force to utilize the refrigerant.

Accumulator: a storage vessel for liquid refrigerant; also known as surge drum.

Bubble point: the temperature at which the vapor pressure of the liquid refrigerant equals the absolute external pressure of the liquid-vapor interface.

Capacity, refrigerating system: the cooling effect produced by the total enthalpy change between the refrigerant entering the evaporator and the refrigerant leaving the evaporator.

Chiller, Evaporator: a heat exchanger in which the liquid refrigerant is vaporized by a process stream which is in turn cooled.

Coefficient of Performance (COP) – the ratio of desired output divided by the required input. It is the rate of how well the heat pump or refrigerator is performing. – A component that determine a system's overall efficiency.

Compression ratio: ratio of outlet to inlet absolute pressures for a compressor.

Compressor – A device that compressing the fluid to raise its pressure.

Condenser: a heat exchanger in which the refrigerant, compressed to a suitable pressure, is condensed by rejection of heat to a cooling medium.

Cooling medium: any substance whose temperature is such that it is used, with or without change of state, to lower the temperature of refrigerant either during condensing or subcooling.

Cyclic Refrigeration – A cycle that take place in the refrigerant as it alternately absorbs and rejects heat as it circulates through refrigerator.

Effect, refrigerating: the rate of heat removal by a refrigerant in a refrigeration system. It is equal to the difference in specific enthalpies of the refrigerant at two designated thermodynamic states.

These design guideline are believed to be as accurate as possible, but are very general and not for specific design cases. They were designed for engineers to do preliminary designs and process specification sheets. The final design must always be guaranteed for the service selected by the manufacturing vendor, but these guidelines will greatly reduce the amount of up front engineering hours that are required to develop the final design. The guidelines are a training tool for young engineers or a resource for engineers with experience.

This document is entrusted to the recipient personally, but the copyright remains with us. It must not be copied, reproduced or in any way communicated or made accessible to third parties without our written consent.

KLM Technology Group Practical Engineering Guidelines for Processing Plant Solutions	REFRIGERATION SYSTEMS (PROCESS ENGINEERING EQUIPMENT DESIGN GUIDELINES)	Page 22 of 95
		Rev: 02
		April 2014

Evaporator – A device used to turn the liquid into gaseous form. Heat exchanger used to absorb heat energy.

Expansion valve – A device that used to control an expansion of liquid refrigerant. Controls the flow of refrigerant and allows for phase change from a liquid to vapor.

Flash chamber – mixing chamber where both liquid and vapor are stored.

Flash gas: the gas resulting from the instantaneous evaporation of refrigerant by a pressure reducing device, such as a control valve.

Frost Plug: small diameter closed nozzle protruding from the side of an insulated vessel which indicates liquid level in the vessel by accumulation of frost.

Halocarbons: a family of refrigerants consisting of fluorinated and/or chlorinated hydrocarbons.

Heat Pump – A device that provides heat energy from a source of heat to another destination.

Hot gas bypass: warm discharge gas recycled to chiller for maintaining system's operating integrity at minimum load conditions.

Liquid Absorbents. A solution known as liquid absorbent is often used to absorb the vaporized refrigerant (water vapor) after its evaporation in an absorption refrigeration system. This solution, containing the absorbed vapor, is then heated at high pressure. The refrigerant vaporizes, and the solution is restored to its original concentration for reuse.

Liquid refrigerant receiver: a vessel in a refrigeration system designed to ensure the availability of adequate liquid refrigerant for proper functioning of the system and to store the liquid refrigerant when the system is pumped down.

Refrigerant – A substance that used as a medium to cool the process in refrigeration system. the fluid used for heat transfer in a refrigeration system, which absorbs heat at a low temperature and low pressure and rejects heat at a higher temperature and a higher pressure.

These design guideline are believed to be as accurate as possible, but are very general and not for specific design cases. They were designed for engineers to do preliminary designs and process specification sheets. The final design must always be guaranteed for the service selected by the manufacturing vendor, but these guidelines will greatly reduce the amount of up front engineering hours that are required to develop the final design. The guidelines are a training tool for young engineers or a resource for engineers with experience.

This document is entrusted to the recipient personally, but the copyright remains with us. It must not be copied, reproduced or in any way communicated or made accessible to third parties without our written consent.

KLM Technology Group Practical Engineering Guidelines for Processing Plant Solutions	REFRIGERATION SYSTEMS (PROCESS ENGINEERING EQUIPMENT DESIGN GUIDELINES)	Page 23 of 95
		Rev: 02
		April 2014

Refrigeration – A process in which work is done to move heat from one circumstances to the other environment. the heat transfer of heat from a lower temperature region to a higher temperature one. A device called a refrigerator or heat pump accomplishes refrigeration.

Refrigerator – A common devices that consists of a thermal insulated and a heat pump that transfers heat from inside compartment (for cooling process) to its environment.

Steam-Jet refrigeration – One of the kind of refrigeration process that used high-pressure jet of steam driving force to utilize the refrigerant.

Thermocouple – Temperature sensor consisting of the junction of two dissimilar metals. The output voltage produced is a function of the difference in the temperature between the hot and cold junction.

T-s diagram – schematic or graphical representation of the temperature versus entropy for refrigeration cycles.

Turbine – device used to extract heat energy to produce mechanical energy.

Vapor-compression – One of the kind of refrigeration process that used mechanical driving force to utilize the refrigerant.

These design guideline are believed to be as accurate as possible, but are very general and not for specific design cases. They were designed for engineers to do preliminary designs and process specification sheets. The final design must always be guaranteed for the service selected by the manufacturing vendor, but these guidelines will greatly reduce the amount of up front engineering hours that are required to develop the final design. The guidelines are a training tool for young engineers or a resource for engineers with experience.

This document is entrusted to the recipient personally, but the copyright remains with us. It must not be copied, reproduced or in any way communicated or made accessible to third parties without our written consent.

KLM Technology Group Practical Engineering Guidelines for Processing Plant Solutions	REFRIGERATION SYSTEMS (PROCESS ENGINEERING EQUIPMENT DESIGN GUIDELINES)	Page 24 of 95
		Rev: 02
		April 2014

NOMENCLATURE

CoP	Coefficient of Performance (%)
h	Enthalpy (kJ/kg)
m	Mass flow rate (kg/s)
Mr	Molecular Mass
P_c	Critical Pressure (MPa)
p_c	Pressure at Condenser (kPa)
p_0	Pressure at Evaporator (kPa)
Q	Heat that been removed (kJ)
R	Refrigerating Capacity (kJ/kg)
R	Universal Gas Constant (J/mol.K)
r_{in}	Radius of exit of impeller (m)
r_{out}	Radius of inlet of impeller (m)
S	Entropy (J/K)
T	Temperature (K)
T_c	Critical Temperature (K)
T_0	Thermodynamics temperature of the environment (K)
T_L	Thermodynamics temperature of the refrigerated space (K)
T_s	Thermodynamics temperature of heat source (K)
W	The work done to the system (kJ)

SYMBOLS

Δh	Discharge head (m)
$\mu_{tang.out}$	Tangential velocity of refrigerant leaving the impeller (m/s)
$\mu_{tang.in}$	Tangential velocity of refrigerant enter the impeller (m/s)
χ	Isentropic Exponent

These design guideline are believed to be as accurate as possible, but are very general and not for specific design cases. They were designed for engineers to do preliminary designs and process specification sheets. The final design must always be guaranteed for the service selected by the manufacturing vendor, but these guidelines will greatly reduce the amount of up front engineering hours that are required to develop the final design. The guidelines are a training tool for young engineers or a resource for engineers with experience.

This document is entrusted to the recipient personally, but the copyright remains with us. It must not be copied, reproduced or in any way communicated or made accessible to third parties without our written consent.